

ROHRSYSTEME
MADE IN
GERMANY



 **MAINCOR**



RANGE OF PRODUCTS



www.maincor.de



info@maincor.de



facebook.com/MaincorRohrsysteme



Mainpex
Sliding Sleeve System



Mainpress
Pressing System



Mainfloor
Underfloor Heating System



Mainair
Residential Ventilation System

Subject to changes of products, product details and technical specifications.

Exemplary illustrations.

No liability for literal errors.



CERTIFICATE

Extended Warranty

We herewith confirm the extension of the warranty for DVGW certified components (pipe and fittings) for the **MAINPEX SLIDING SLEEVE SYSTEM AND MAINPRESS SYSTEM.**

For a period of **10 years**, we will provide replacement for:

- 1) MAINCOR pipe systems MAINPEX (MPX), MAINPRESS (MPR) and MAINPIPE in the event of damage that is demonstrably due to defects in production or material, as far as the manufacturer is held responsible.
- 2) Damage that is caused by production defects to the property of third parties and any resulting consequential losses.
- 3) Expenses of third parties caused by removing, dismantling, disassembly and clearing of defective products as well as for mounting and laying non-defective products to be supplied by us.

The warranty extends to all above mentioned system components such as pipes and fittings insofar as supplied by us. No warranty is granted for laying and installation errors. The technical documentation and application guidelines shall be decisive.

For coverage, there is an extended product liability insurance with a renowned German insurance company with the following sums insured:

- 3.000.000,- EUR lump-sum, for bodily injury as well as economic losses of property and product
- 2.000.000,- EUR maximum sum for an individual person

Schweinfurt, August 1, 2019



Dieter Pfister
Managing director



Michael Pfister
Managing director



CERTIFICATE

Extended Warranty

We herewith confirm the extension of the warranty for pipe products for the underfloor heating system MAINFLOOR:

PE-RT pipe (oxygen-tight because of EVOH layer):

10x1,3; 14x1,5; 14x2,0; 16x1,5; 16x2,0; 17x2,0; 18x2,0; 20x2,0 and 25x2,3

Composite pipe PE-RT/Aluminium/PE-RT: 16x2,0

For a period of **10 years**, we will provide replacement for:

- 1) MAINFLOOR pipe systems in the event of damage that is demonstrably due to defects in production or material.
- 2) Damage that is caused by production defects to the property of third parties and any resulting consequential losses.
- 3) Expenses of third parties caused by removing, dismounting, disassembly and clearing of defective products as well as for mounting and laying non-defective products to be supplied by us.

The warranty extends to all above mentioned system components such as pipes and fittings insofar as supplied by us. No warranty is granted for laying and installation errors. The technical documentation and application guidelines shall be decisive. For coverage, there is an extended product liability insurance with a renowned German insurance company with the following sums insured:

3.000.000,- EUR lump-sum, for bodily injury as well as economic losses of property and product

2.000.000,- EUR maximum sum for an individual person

Schweinfurt, August 1, 2019

Dieter Pfister
Managing director

Michael Pfister
Managing director



Mainpex

Sliding Sleeve System

MORE SAFETY - MORE COMFORT

Double profile

With the first double profile the support sleeve is protected against mechanical damages.

Undercut

Due to the special design of the fittings any contact between the aluminum layer and the fitting body is prevented.

Sleeve can be used on both sides

The sleeve can be mounted in any direction. The right handling is guaranteed because sleeves works on both sides - easy handling.

Fixation of the sleeve

The sleeve is equipped with an additional groove. Here, the material flows in and prevents that the sleeve loses its position.

As there is no need for any additional sealing elements the MAINPEX Sliding sleeve system reaches a higher security level.

Higher flow

By expanding the MAINPEX pipe the cross-section in the joint is substantially larger when compared to traditional joint systems.

Dimension 16 - 50

- 16 x 2,2
- 20 x 2,8
- 25 x 3,5
- 32 x 4,4
- 40 x 4,0
- 50 x 4,5

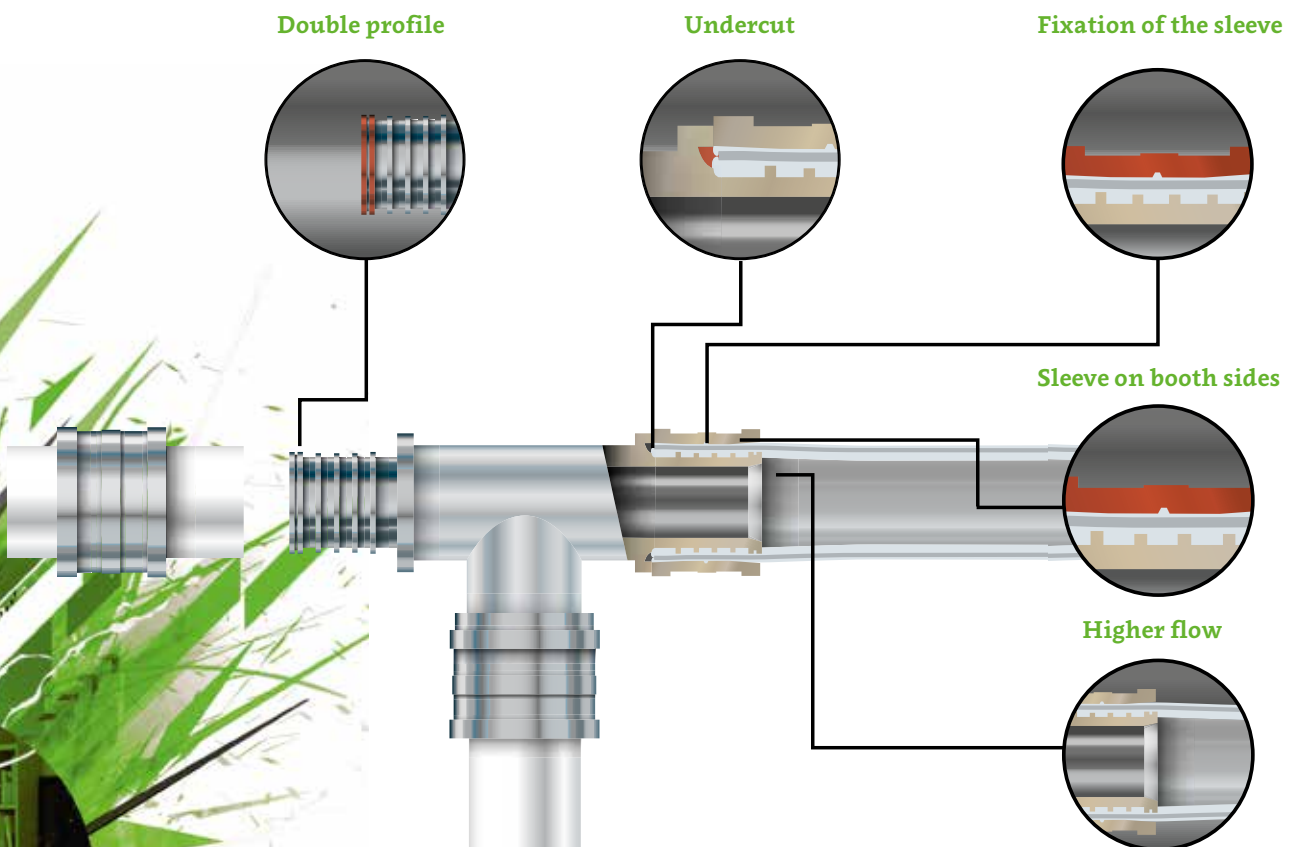

Composite pipe in coils
 PE-RT / Alu / PE-RT

Description/Dim.	Code	PU
16 x 2,2	10.016.220	200 m
20 x 2,8	10.020.280	100 m
25 x 3,5	10.025.350	50 m
32 x 4,4	10.032.440	50 m

Protective pipe

Description/Dim.	Code	PU
20 (for 16 x 2,2) red	520.150	50 m
23 (for 20 x 2,8) red	523.150	50 m
20 (for 16 x 2,2) blue	520.250	50 m
23 (for 20 x 2,8) blue	523.250	50 m
20 (for 16 x 2,2) black	520.350	50 m
23 (for 20 x 2,8) black	523.350	50 m

Composite pipe in bars
 PE-RT / Alu / PE-RT

Description/Dim.	Code	L	PU
16 x 2,2	10.016.221	3,5 m	105 m
20 x 2,8	10.020.281	3,5 m	70 m
25 x 3,5	10.025.351	3,5 m	56 m
32 x 4,4	10.032.441	3,5 m	35 m
40 x 4,0	10.040.401	5 m	20 m
50 x 4,5	10.050.451	5 m	15 m

Sliding sleeve

Description/Dim.	Code	PU
16	20.000.100	100 Pcs
20	20.000.200	100 Pcs
25	20.000.300	50 Pcs
32	20.000.400	50 Pcs
40	20.000.500	10 Pcs
50	20.000.600	10 Pcs

Composite pipe
 PE-RT / Alu / PE-RT, pre-insulated

Description/Dim.	Code	PU
16 x 2,2 / 6 mm red	10.016.224	50 m
20 x 2,8 / 6 mm red	10.020.284	50 m
25 x 3,5 / 6 mm red	10.025.354	50 m
16 x 2,2 / 9 mm red	10.016.229	50 m
20 x 2,8 / 9 mm red	10.020.289	50 m
25 x 3,5 / 9 mm red	10.025.359	50 m
16 x 2,2 / 13 mm red	10.016.2213	50 m
20 x 2,8 / 13 mm red	10.020.2813	50 m
25 x 3,5 / 13 mm red	10.025.3513	50 m
32 x 4,4 / 13 mm red	10.032.4413	25 m
16 x 2,2 / 26 mm red	10.016.2227	25 m
20 x 2,8 / 26 mm red	10.020.2827	25 m
25 x 3,5 / 26 mm red	10.025.3527	25 m
16 x 2,2 / 6 mm blue	10.016.225	50 m
20 x 2,8 / 6 mm blue	10.020.285	50 m

Elbow, 90°

Description/Dim.	Code	PU
16 x 16	40.500.101	10 Pcs
20 x 20	40.500.202	10 Pcs
25 x 25	40.500.303	10 Pcs
32 x 32	40.500.404	5 Pcs
40 x 40	40.500.505	1 Pc
50 x 50	40.500.606	1 Pc

Elbow, 45°

Description/Dim.	Code	PU
25 x 25	40.505.303	10 Pcs
32 x 32	40.505.404	5 Pcs
40 x 40	40.505.505	1 Pc
50 x 50	40.505.606	1 Pc

Pipe-in-pipe
 PE-RT / Alu / PE-RT

Description/Dim.	Code	PU
16 x 2,2	607.162.015.0	50 m
20 x 2,8	607.202.315.0	50 m
25 x 3,5	607.252.912.5	25 m

Tee

Description/Dim.	Code	PU
16 x 16 x 16	40.300.111	10 Pcs
20 x 20 x 20	40.300.222	10 Pcs
25 x 25 x 25	40.300.333	10 Pcs
32 x 32 x 32	40.300.444	5 Pcs
40 x 40 x 40	40.300.555	1 Pc
50 x 50 x 50	40.300.666	1 Pc

MAINPEX



Tee, reduced

Description/Dim.	Code	PU
16 x 20 x 16	40.300.121	10 Pcs
16 x 25 x 16	40.300.131	10 Pcs
20 x 16 x 16	40.300.211	10 Pcs
20 x 16 x 20	40.300.212	10 Pcs
20 x 20 x 16	40.300.221	10 Pcs
20 x 25 x 20	40.300.232	10 Pcs
25 x 16 x 16	40.300.311	10 Pcs
25 x 16 x 20	40.300.312	10 Pcs
25 x 16 x 25	40.300.313	10 Pcs
25 x 20 x 16	40.300.321	10 Pcs
25 x 20 x 20	40.300.322	10 Pcs
25 x 20 x 25	40.300.323	10 Pcs
25 x 25 x 16	40.300.331	10 Pcs
25 x 25 x 20	40.300.332	10 Pcs
32 x 16 x 32	40.300.414	5 Pcs
32 x 20 x 25	40.300.423	5 Pcs
32 x 20 x 32	40.300.424	5 Pcs
32 x 25 x 25	40.300.433	5 Pcs
32 x 25 x 32	40.300.434	5 Pcs
40 x 32 x 40	40.300.545	1 Pc
40 x 32 x 32	40.300.544	1 Pc
40 x 20 x 40	40.300.525	1 Pc
50 x 20 x 50	40.300.626	1 Pc
50 x 32 x 50	40.300.646	1 Pc
50 x 40 x 40	40.300.655	1 Pc
50 x 40 x 50	40.300.656	1 Pc



Transit elbow

Description/Dim.	Code	PU
16 x 1/2" FT x 16	40.324.111	1 Pc
20 x 1/2" FT x 20	40.324.212	1 Pc



Wall elbow, female thread

Description/Dim.	Code	PU
16 x 1/2" FT	40.603.101	10 Pcs
20 x 1/2" FT	40.603.201	10 Pcs
20 x 3/4" FT	40.603.202	5 Pcs
25 x 3/4" FT	40.603.302	5 Pcs



Connector, male thread

Description/Dim.	Code	PU
16 x 3/8" MT	30.202.100	10 Pcs
16 x 1/2" MT	30.202.101	10 Pcs
16 x 3/4" MT	30.202.102	10 Pcs
20 x 1/2" MT	30.202.201	10 Pcs
20 x 3/4" MT	30.202.202	10 Pcs
25 x 3/4" MT	30.202.302	10 Pcs
25 x 1" MT	30.202.303	10 Pcs
32 x 1" MT	30.202.403	5 Pcs
32 x 1 1/4" MT	30.202.404	5 Pcs
40 x 1 1/4" MT	30.202.504	1 Pc
40 x 1 1/2" MT	30.202.505	1 Pc
50 x 1 1/2" MT	30.202.605	1 Pc



Tee, female thread

Description/Dim.	Code	PU
16 x 1/2" FT x 16	40.303.111	10 Pcs
20 x 1/2" FT x 20	40.303.212	10 Pcs
20 x 3/4" FT x 20	40.303.222	10 Pcs
25 x 1/2" FT x 25	40.303.313	10 Pcs
25 x 3/4" FT x 25	40.303.323	10 Pcs
32 x 1/2" FT x 32	40.303.414	5 Pcs
40 x 1" FT x 40	40.303.535	1 Pc
50 x 1" FT x 50	40.303.636	1 Pc



Connector, female thread

Description/Dim.	Code	PU
16 x 3/8" FT	30.203.100	10 Pcs
16 x 1/2" FT	30.203.101	10 Pcs
16 x 3/4" FT	30.203.102	10 Pcs
20 x 1/2" FT	30.203.201	10 Pcs
20 x 3/4" FT	30.203.202	10 Pcs
25 x 3/4" FT	30.203.302	10 Pcs
25 x 1" FT	30.203.303	10 Pcs
32 x 3/4" FT	30.203.402	5 Pcs
32 x 1" FT	30.203.403	5 Pcs
40 x 1 1/4" FT	30.203.504	1 Pc
50 x 1 1/2" FT	30.203.605	1 Pc



Elbow 90°, male thread

Description/Dim.	Code	PU
16 x 1/2" MT	40.402.101	10 Pcs
20 x 1/2" MT	40.402.201	10 Pcs
20 x 3/4" MT	40.402.202	10 Pcs
25 x 3/4" MT	40.402.302	10 Pcs
32 x 3/4" MT	40.402.402	5 Pcs
32 x 1" MT	40.402.403	5 Pcs
40 x 1 1/4" MT	40.402.504	1 Pc
50 x 1 1/2" MT	40.402.605	1 Pc

Elbow 90°, female thread

Description/Dim.	Code	PU
16 x 1/2" FT	40.403.101	10 Pcs
20 x 1/2" FT	40.403.201	10 Pcs
20 x 3/4" FT	40.403.202	10 Pcs
25 x 3/4" FT	40.403.302	10 Pcs
32 x 1" FT	40.403.403	5 Pcs

Push and press joint

Description/Dim.	Code	PU
16 x 15	30.207.101	10 Pcs
20 x 22	30.207.203	10 Pcs
25 x 22	30.207.303	10 Pcs
32 x 28	30.207.404	5 Pcs

Coupler

Description/Dim.	Code	PU
16 x 16	30.100.101	10 Pcs
20 x 20	30.100.202	10 Pcs
25 x 25	30.100.303	10 Pcs
32 x 32	30.100.404	5 Pcs
40 x 40	30.100.505	1 Pc
50 x 50	30.100.606	1 Pc

Joint union nut, female thread

Description/Dim.	Code	PU
16 x 3/4" FT	40.201.102	10 Pcs
20 x 3/4" FT	40.201.202	10 Pcs
25 x 1" FT	40.201.303	10 Pcs
32 x 1 1/4" FT	40.201.404	5 Pcs

Coupler, reduced

Description/Dim.	Code	PU
20 x 16	30.100.201	10 Pcs
25 x 16	30.100.301	10 Pcs
25 x 20	30.100.302	10 Pcs
32 x 20	30.100.402	5 Pcs
32 x 25	30.100.403	5 Pcs
40 x 32	30.100.504	1 Pc
50 x 40	30.100.605	1 Pc



Mount for wall elbows

Description/Dim.	Code	PU
h = 35 mm	70.700.000	10 Pcs
h = 45 mm	70.700.450	10 Pcs
h = 50 mm	70.701.000	10 Pcs

to be used with sound separator

Dummy plug

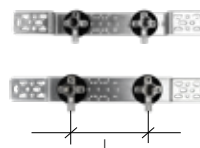
Description/Dim.	Code	PU
16	30.200.100	10 Pcs
20	30.200.200	10 Pcs

Mount for wall elbows, pre-assembled

Description/Dim.	Code	PU
l = 80 mm on wall	70.702.000	1 Pc
l = 153 mm on wall	70.703.000	1 Pc
l = 80 mm in wall	70.702.001	1 Pc
l = 153 mm in wall	70.703.001	1 Pc

similar to illustration

Mount for wall elbows, pre-assembled with noise cancellation equipment

Description/Dim.	Code	PU
l = 153 mm in wall, 16	70.703.002	1 Pc
l = 153 mm in wall, 20	70.703.003	1 Pc

Pressure test plug

Description/Dim.	Code	PU
16 x 2,2	40.900.001	1 Pc
20 x 2,8	40.900.002	1 Pc
25 x 3,5	40.900.003	1 Pc

Connector for soldering CU

Description/Dim.	Code	PU
16 x CU 15 - 18	30.207.100	10 Pcs
20 x CU 18 - 22	30.207.150	10 Pcs
20 x CU 22 - 28	30.207.200	10 Pcs
25 x CU 22 - 28	30.207.300	10 Pcs
32 x CU 28 - 35	30.207.400	5 Pcs

Noise cancellation equipment for wall elbows

Description/Dim.	Code	PU
(1) Casing for wall elbow	70.700.100	2 Pcs
(2) Sound separator	70.700.300	2 Pcs
(3) Screw for wall elbow and sound separator	70.700.201	100 Pcs
(4) M5 x 12 screw	70.700.204	100 Pcs
(5) Base plate	70.700.302	2 Pcs

MAINPEX



Sanibox

Description/Dim.	Code	PU
Sanibox	70.600.007	1 Pc



Crossing tee

Description/Dim.	Code	PU
16 x 16 x 16	40.310.111	1 Pc
20 x 16 x 16	40.310.211	1 Pc
20 x 16 x 20	40.310.221	1 Pc
20 x 20 x 20	40.310.222	1 Pc



Base board radiator adapter

Description/Dim.	Code	PU
16-l-300	70.800.100	1 Pc
16-l-1000	70.800.300	1 Pc



Bolt connection for radiator adapter

Description/Dim.	Code	PU
15 x 3/4"	70.709.065	2 Pcs



Joint for valve radiators

Description/Dim.	Code	PU
Twofold joint 3/4"	80.902.200	1 Pc
Twofold joint square form 3/4"	80.902.201	1 Pc



Joint euro cone

Description/Dim.	Code	PU
Joint euro cone 16 x 3/4"	30.206.100	2 Pcs
Joint euro cone 20 x 3/4"	30.206.200	2 Pcs



Screw plug

Description/Dim.	Code	PU
red	70.700.250	2 Pcs
blue	70.700.251	2 Pcs

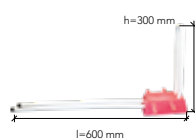

Radiator terminal box

Description/Dim.	Code	PU
Radiator terminal box	80.900.101	1 Pc

similar to illustration



Radiator connection nipples

Description/Dim.	Code	PU
Radiator connection nipples	70.709.066	2 Pcs



Compression fitting

Description/Dim.	Code	PU
16 x 2,2 x 3/4"	70.709.062	2 Pcs
20 x 2,8 x 3/4"	70.709.064	2 Pcs

similar to illustration

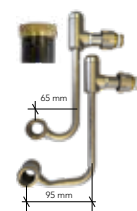

Attachment fitting for baseboard

Description/Dim.	Code	PU
Attachment fitting for baseboard	80.902.300	1 Pc
End cap	80.902.302	1 Pc



Euro cone adapter

Description/Dim.	Code	PU
3/4"	80.902.303	10 Pcs



Anchor hook

Description/Dim.	Code	PU
80 mm, single	800.907	100 Pcs
85 mm, double	801.007	100 Pcs



Fitting rack

Description/Dim.	Code	PU
Fitting rack, empty	60.953.000	1 Pc



Fitting case

Description/Dim.	Code	PU
Fitting case, empty	60.951.007	1 Pc



Set 1: Compression tool set 16 - 32

Description/Dim.	Code	PU
Compression tool set 16 - 32	90.100.056	1 Set
Set consist of:		
Compression tool 16 - 32	61.950.006	1 Pc
Expansion adapter 16 - 32	61.950.021	1 Pc
Sliding jaw set 16/17	60.950.171	1 Pc
Sliding jaw set 20	60.950.172	1 Pc
Sliding jaw set 25	60.950.173	1 Pc
Sliding jaw set 32 (for 16 - 32)	60.950.174	1 Pc
Expansion head 16	60.950.031	1 Pc
Expansion head 20	60.950.032	1 Pc
Expansion head 25	60.950.033	1 Pc
Expansion head 32	60.950.034	1 Pc
Battery 18V 1,5 Ah	60.950.007.1	1 Pc
Battery charger 230V	60.952.202.1	1 Pc
Case for Compression tool 16 - 32	61.950.004	1 Pc



Set 2: Compression tool set 16 - 32 without accessories

Description/Dim.	Code	PU
Compression tool set 16 - 32 without accessories	61.950.007	1 Set
Set consist of:		
Compression tool 16 - 32	61.950.006	1 Pc
Expansion adapter 16 - 32	61.950.021	1 Pc
Battery 18V 1,5 Ah	60.950.007.1	1 Pc
Battery charger 230V	60.952.202.1	1 Pc
Case for Compression tool 16 - 32	61.950.004	1 Pc



Set 3: Compression tool set 32 - 50

Description/Dim.	Code	PU
Compression tool set 32 - 50	90.100.053	1 Set
Set consist of:		
Compression tool 32 - 50	62.950.006	1 Pc
Expansion adapter 32 - 50	62.950.021	1 Pc
Sliding jaw set 32 (for 32 - 50)	62.950.174	1 Pc
Sliding jaw set 40	62.950.175	1 Pc
Sliding jaw set 50	62.950.176	1 Pc
Expansion head 32	60.950.034	1 Pc
Expansion head 40	60.950.035	1 Pc
Expansion head 50	60.950.036	1 Pc
Battery 18V 4,0 Ah	60.953.204	1 Pc
Battery charger 230V	60.952.202.1	1 Pc
Case for Compression tool 32 - 50	62.950.004	1 Pc



Set 4: Compression tool set 32 - 50 without accessories

Description/Dim.	Code	PU
Compression tool set 32 - 50 without accessories	62.950.007	1 Set
Set consist of:		
Compression tool 32 - 50	62.950.006	1 Pc
Expansion adapter 32 - 50	62.950.021	1 Pc
Battery 18V 4,0 Ah	60.953.204	1 Pc
Battery charger 230V	60.952.202.1	1 Pc
Case for Compression tool 32 - 50	62.950.004	1 Pc



Set 5: Manual expansion tool set

Description/Dim.	Code	PU
Manual expansion tool set 16 - 32	90.100.061	1 Set
Set consist of:		
Expansion tool	60.950.030	1 Pc
Expansion head 16	60.950.031	1 Pc
Expansion head 20	60.950.032	1 Pc
Expansion head 25	60.950.033	1 Pc
Expansion head 32	60.950.034	1 Pc

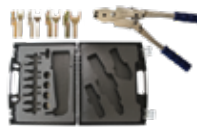

Set 6: Manual compression tool set

Description/Dim.	Code	PU
Manual compression tool set	90.100.063	1 Set
Set consist of:		
Lokring tool 16 - 32	60.950.102	1 Pc
Sliding jaw kit 16	60.950.177	1 Pc
Sliding jaw kit 20	60.950.178	1 Pc
Sliding jaw kit 25	60.950.179	1 Pc
Sliding jaw kit 32	60.950.180	1 Pc
Case for manual compression tool	60.950.181	1 Pc



Set 7: Manual compression and expansion tool set 16 - 32

Description/Dim.	Code	PU
Manual compression and expansion tool set 16 - 32	90.100.064	1 Set
Set consist of:		
Manual expansion tool	60.950.030	1 Pc
Lokring tool 16 - 32	60.950.102	1 Pc
Sliding jaw kit 16	60.950.177	1 Pc
Sliding jaw kit 20	60.950.178	1 Pc
Sliding jaw kit 25	60.950.179	1 Pc
Sliding jaw kit 32	60.950.180	1 Pc
Expansion head 16	60.950.031	1 Pc
Expansion head 20	60.950.032	1 Pc
Expansion head 25	60.950.033	1 Pc
Expansion head 32	60.950.034	1 Pc
Case for manual compression tool	60.950.181	1 Pc

MAINPEX



Sliding jaw 50 incl. adapter

Description/Dim.	Code	PU
Sliding jaw 50 incl. adapter	90.100.080	1 Pc



Scissor

Description/Dim.	Code	PU
16 - 20	60.950.014	1 Pc
Replacement blade	60.950.114	1 Pc



Expansion head

Description/Dim.	Code	PU
Expansion head 16	60.950.031	1 Pc
Expansion head 20	60.950.032	1 Pc
Expansion head 25	60.950.033	1 Pc
Expansion head 32	60.950.034	1 Pc
Expansion head 40	60.950.035	1 Pc
Expansion head 50	60.950.036	1 Pc



Pipe cutter

Description/Dim.	Code	PU
16 - 40	60.950.011	1 Pc
Replacement blade	60.950.112	1 Pc



Bending spring

Description/Dim.	Code	PU
Ø 16 OS	60.950.140	1 Pc
Ø 20 OS	60.950.141	1 Pc
Ø 25 OS	60.950.142	1 Pc
Ø 32 OS	60.950.143	1 Pc
Ø 20 IS	60.950.047	1 Pc



Pipe cutter

Description/Dim.	Code	PU
16 - 63	60.950.013	1 Pc



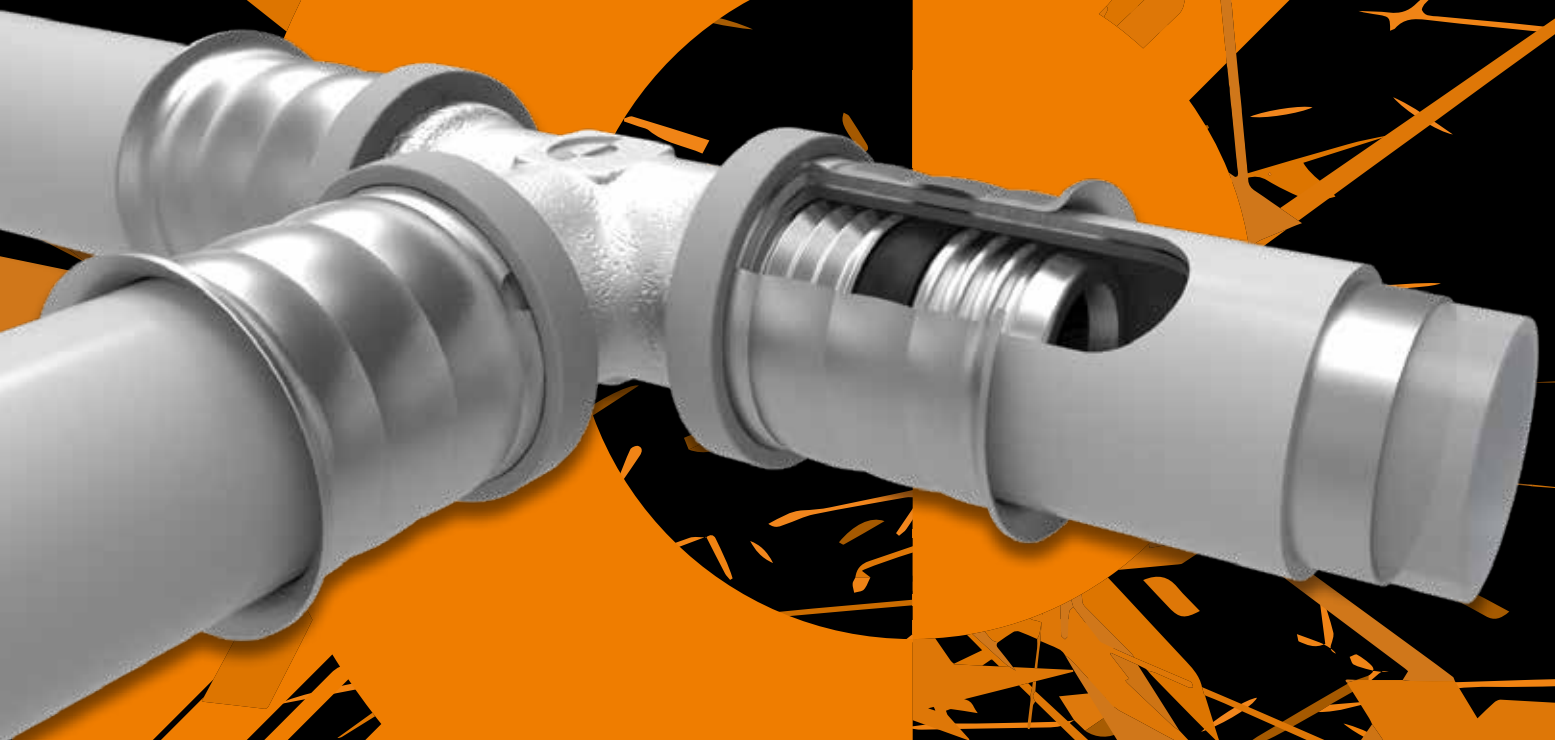

Mainpress

Pressing System

NO STRESS WITH PRESS

Sealing element

MAINPRESS fittings have D-Shaped sealing elements which are safer than common O-rings, as the sealing element is protected and thus cannot be displaced.

Increased safety

For security reasons MAINPRESS fittings have inspection windows to indicate the correct insertion of the pipe. As a safety function the fittings are leaking when not pressed.

Sleeve

The sleeve is made of stainless steel with an unremoveable press stop which ensures the correct alignment of the press jaws. Due to the material the sleeve is prevented from corrosion.

Compatibility

Our MAINPRESS pressing system with MAINPIPE multilayer composite pipe PE-RT/AL/PE-RT is compatible with:

- UPONOR-UNIPIPE MLC composite pipes and MLC press fittings
- WAVIN composite pipes and K1 press fittings
- MULTITUBO composite pipes and MT press fittings
- KEKELIT-KELOX composite pipe and KW/KM press fittings
- Jupiter-Perfekt Aqua composite pipes and MP/KF press fittings
- the regular pressing tools with a U pressing profile (KSP5)

Dimension 16 - 63

- 16 x 2,0
- 20 x 2,25
- 25 x 2,5
- 32 x 3,0
- 40 x 4,0
- 50 x 4,5
- 63 x 6,0

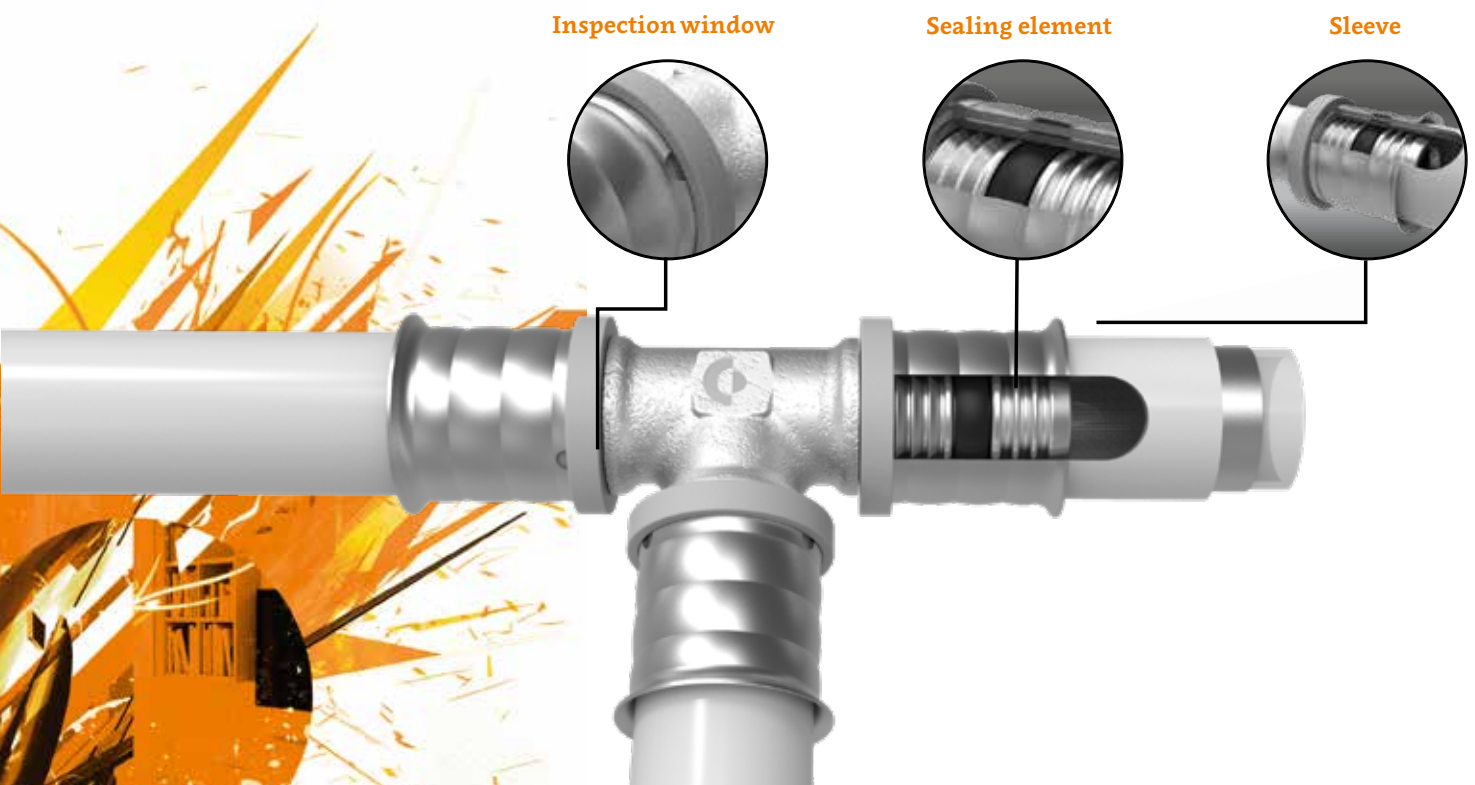

Composite pipe in coils
 PE-RT / Alu / PE-RT

Description/Dim.	Code	PU
16 x 2,0	816.001.410.0	100 m*
16 x 2,0	816.001.420.0	200 m*
16 x 2,0	816.001.450.0	500 m*
20 x 2,25	820.001.410.0	100 m*
25 x 2,5	825.001.405.0	50 m*
32 x 3,0	832.001.405.0	50 m*

* other coil lengths available on request

Composite pipe in bars
 PE-RT / Alu / PE-RT

Description/Dim.	Code	L	PU
16 x 2,0	816.001.400.3	3,5 m	77 m
16 x 2,0	816.001.400.5	5 m	110 m
20 x 2,25	820.001.400.3	3,5 m	42 m
20 x 2,25	820.001.400.5	5 m	80 m
25 x 2,5	825.001.400.3	3,5 m	28 m
25 x 2,5	825.001.400.5	5 m	40 m
32 x 3,0	832.001.400.3	3,5 m	17,5 m
32 x 3,0	832.001.400.5	5 m	25 m
40 x 4,0	10.140.401	5 m	20 m
50 x 4,5	10.150.451	5 m	15 m
63 x 6,0	10.160.601	5 m	5 m

Pipe-in-pipe
 PE-RT / Alu / PE-RT

Description/Dim.	Code	PU
16 x 2,0	611.162.035.0	50 m
20 x 2,25	611.202.335.0	50 m

Protective pipe

Description/Dim.	Code	PU
20 (for 16 x 2,2) red	520.150	50 m
23 (for 20 x 2,8) red	523.150	50 m
20 (for 16 x 2,2) blue	520.250	50 m
23 (for 20 x 2,8) blue	523.250	50 m
20 (for 16 x 2,2) black	520.350	50 m
23 (for 20 x 2,8) black	523.350	50 m

Elbow, 90°

Description/Dim.	Code	PU
16 x 16	41.500.101	10 Pcs
20 x 20	41.500.202	10 Pcs
25 x 25	41.500.303	10 Pcs
32 x 32	41.500.404	5 Pcs
40 x 40	41.500.505	1 Pc
50 x 50	41.500.606	1 Pc
63 x 63	41.500.707	1 Pc

Composite pipe
 PE-RT / Alu / PE-RT, pre-insulated

Description/Dim.	Code	PU
16 x 2,0 / 6 mm grey	10.016.204	50 m
20 x 2,25 / 6 mm grey	10.020.224	50 m
25 x 2,5 / 6 mm grey	10.025.254	50 m

16 x 2,0 / 9 mm grey	10.016.209	50 m
20 x 2,25 / 9 mm grey	10.020.229	50 m
25 x 2,5 / 9 mm grey	10.025.259	50 m

16 x 2,0 / 13 mm grey	10.016.2013	50 m
20 x 2,25 / 13 mm grey	10.020.2213	50 m
25 x 2,5 / 13 mm grey	10.025.2513	50 m
32 x 3,0 / 13 mm grey	10.032.3013	25 m

16 x 2,0 / 26 mm grey	10.016.2027	25 m
20 x 2,25 / 26 mm grey	10.020.2227	25 m
25 x 2,5 / 26 mm grey	10.025.2527	25 m



16 x 2,0 / 6 mm red	10.316.206	50 m
20 x 2,25 / 6 mm red	10.320.226	50 m
25 x 2,5 / 6 mm red	10.325.256	50 m



16 x 2,0 / 6 mm blue	10.216.206	50 m
20 x 2,25 / 6 mm blue	10.220.226	50 m
25 x 2,5 / 6 mm blue	10.225.256	50 m

Tee

Description/Dim.	Code	PU
16 x 16 x 16	41.300.111	10 Pcs
20 x 20 x 20	41.300.222	10 Pcs
25 x 25 x 25	41.300.333	10 Pcs
32 x 32 x 32	41.300.444	5 Pcs
40 x 40 x 40	41.300.555	1 Pc
50 x 50 x 50	41.300.666	1 Pc
63 x 63 x 63	41.300.777	1 Pc

Tee, female thread

Description/Dim.	Code	PU
16 x 1/2" FT x 16	41.303.111	10 Pcs
20 x 1/2" FT x 20	41.303.212	10 Pcs
25 x 1/2" FT x 25	41.303.313	10 Pcs
25 x 3/4" FT x 25	41.303.323	10 Pcs
32 x 3/4" FT x 32	41.303.424	5 Pcs
32 x 1" FT x 32	41.303.434	5 Pcs
40 x 1" FT x 40	41.303.535	1 Pc
50 x 1" FT x 50	41.303.636	1 Pc

Wall elbow, female thread

Description/Dim.	Code	PU
16 x 1/2" FT	41.603.101	10 Pcs
20 x 1/2" FT	41.603.201	10 Pcs
20 x 3/4" FT	41.603.202	10 Pcs



MAINPRESS



Transit elbow

Description/Dim.	Code	PU
16 x 1/2" FT x 16	41.324.111	10 Pcs
20 x 1/2" FT x 20	41.324.212	10 Pcs



Tee, reduced

Description/Dim.	Code	PU
16 x 20 x 16	41.300.121	10 Pcs
20 x 16 x 16	41.300.211	10 Pcs
20 x 16 x 20	41.300.212	10 Pcs
20 x 20 x 16	41.300.221	10 Pcs
25 x 16 x 16	41.300.311	10 Pcs
25 x 16 x 25	41.300.313	10 Pcs
25 x 20 x 20	41.300.322	10 Pcs
25 x 20 x 25	41.300.323	10 Pcs
25 x 25 x 16	41.300.331	10 Pcs
32 x 16 x 32	41.300.414	5 Pcs
32 x 20 x 32	41.300.424	5 Pcs
32 x 25 x 25	41.300.433	5 Pcs
32 x 25 x 32	41.300.434	5 Pcs
40 x 20 x 40	41.300.525	1 Pc
40 x 25 x 40	41.300.535	1 Pc
40 x 32 x 32	41.300.544	1 Pc
40 x 32 x 40	41.300.545	1 Pc
50 x 25 x 50	41.300.636	1 Pc
50 x 32 x 50	41.300.646	1 Pc
50 x 40 x 50	41.300.656	1 Pc
63 x 40 x 63	41.300.757	1 Pc



Elbow 90°, male thread

Description/Dim.	Code	PU
16 x 1/2" MT	41.402.101	10 Pcs
20 x 1/2" MT	41.402.201	10 Pcs
20 x 3/4" MT	41.402.202	10 Pcs
25 x 3/4" MT	41.402.302	10 Pcs
25 x 1" MT	41.402.303	10 Pcs
32 x 1" MT	41.402.404	5 Pcs



Elbow 90°, female thread

Description/Dim.	Code	PU
16 x 1/2" FT	41.403.101	10 Pcs
20 x 1/2" FT	41.403.201	10 Pcs
20 x 3/4" FT	41.403.202	10 Pcs
25 x 3/4" FT	41.403.302	10 Pcs
25 x 1" FT	41.403.303	10 Pcs
32 x 1" FT	41.403.403	5 Pcs



Coupler

Description/Dim.	Code	PU
16 x 16	31.100.101	10 Pcs
20 x 20	31.100.202	10 Pcs
25 x 25	31.100.303	10 Pcs
32 x 32	31.100.404	5 Pcs
40 x 40	31.100.505	1 Pc
50 x 50	31.100.606	1 Pc
63 x 63	31.100.707	1 Pc



Connector, male thread

Description/Dim.	Code	PU
16 x 3/8" MT	31.202.103	10 Pcs
16 x 1/2" MT	31.202.101	10 Pcs
16 x 3/4" MT	31.202.102	10 Pcs
20 x 1/2" MT	31.202.201	10 Pcs
20 x 3/4" MT	31.202.202	10 Pcs
25 x 3/4" MT	31.202.302	10 Pcs
25 x 1" MT	31.202.303	10 Pcs
32 x 1" MT	31.202.403	5 Pcs
32 x 1 1/4" MT	31.202.404	5 Pcs
40 x 1 1/4" MT	31.202.504	1 Pc
40 x 1 1/2" MT	31.202.505	1 Pc
50 x 1 1/2" MT	31.202.605	1 Pc
50 x 2" MT	31.202.606	1 Pc
63 x 2" MT	31.202.706	1 Pc



Coupler, reduced

Description/Dim.	Code	PU
20 x 16	31.100.201	10 Pcs
25 x 16	31.100.301	10 Pcs
25 x 20	31.100.302	10 Pcs
32 x 20	31.100.402	5 Pcs
32 x 25	31.100.403	5 Pcs
40 x 32	31.100.504	1 Pc
50 x 32	31.100.604	1 Pc
50 x 40	31.100.605	1 Pc
63 x 40	31.100.705	1 Pc
63 x 50	31.100.706	1 Pc



Dummy plug

Description/Dim.	Code	PU
16 x 2,0	31.200.100	1 Pc
20 x 2,25	31.200.200	1 Pc



Connector, female thread

Description/Dim.	Code	PU
16 x 3/8" FT	31.203.103	10 Pcs
16 x 1/2" FT	31.203.101	10 Pcs
16 x 3/4" FT	31.203.102	10 Pcs
20 x 1/2" FT	31.203.201	10 Pcs
20 x 3/4" FT	31.203.202	10 Pcs
25 x 3/4" FT	31.203.302	10 Pcs
25 x 1" FT	31.203.303	10 Pcs
32 x 1" FT	31.203.403	5 Pcs
32 x 1 1/4" FT	31.203.404	5 Pcs



Push and press joint

Description/Dim.	Code	PU
16 x 12	31.207.102	10 Pcs
16 x 15	31.207.101	10 Pcs
20 x 18	31.207.202	10 Pcs
20 x 22	31.207.203	10 Pcs
25 x 22	31.207.303	10 Pcs
32 x 28	31.207.404	5 Pcs



Mount for wall elbows, pre-assembled with noise cancellation equipment

Description/Dim.	Code	PU
l = 153 mm in wall, 16	71.703.002	1 Pc
l = 153 mm in wall, 20	71.703.003	1 Pc



Joint union nut, female thread

Description/Dim.	Code	PU
16 x 1/2" FT	41.201.101	10 Pcs
16 x 3/4" FT	41.201.102	10 Pcs
20 x 1/2" FT	41.201.201	10 Pcs
20 x 3/4" FT	41.201.202	10 Pcs
25 x 1" FT	41.201.303	10 Pcs
32 x 1 1/4" FT	41.201.404	5 Pcs



Screw plug

Description/Dim.	Code	PU
red	70.700.250	1 Pc
blue	70.700.251	1 Pc

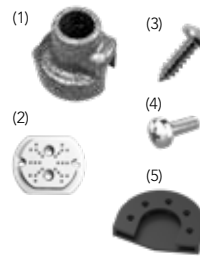

Noise cancellation equipment for wall elbows

Description/Dim.	Code	PU
(1) Casing for wall elbow	70.700.100	2 Pcs
(2) Sound separator	70.700.300	2 Pcs
(3) Screw for wall elbow and sound separator	70.700.201	100 Pcs
(4) M5 x 12 screw	70.700.204	100 Pcs
(5) Mounting plate	70.700.302	2 Pcs



Pressure test plug

Description/Dim.	Code	PU
16 x 2,0	41.900.001	1 Pc
20 x 2,25	41.900.002	1 Pc
25 x 2,5	41.900.003	1 Pc
32 x 3,0	41.900.004	1 Pc



Sanibox

Description/Dim.	Code	PU
Sanibox	70.600.007	1 Pc



Dry wall penetration

Description/Dim.	Code	PU
1/2" FT x 1/2" MT - short	70.700.601	1 Pc
1/2" FT x 1/2" MT - long	70.700.600	1 Pc

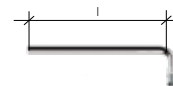

Base board radiator adapter

Description/Dim.	Code	PU
16-I-300	71.800.100	1 Pc
16-I-1000	71.800.300	1 Pc



Mount for wall elbows

Description/Dim.	Code	PU
h = 35 mm	70.700.000	10 Pcs
h = 45 mm	70.700.450	10 Pcs
h = 50 mm	70.701.000	10 Pcs

to be used with sound separator



Bolt connection for radiator adapter

Description/Dim.	Code	PU
15 x 3/4"	70.709.065	2 Pcs

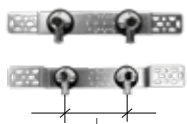

Mount for wall elbows, pre-assembled

Description/Dim.	Code	PU
l = 80 mm on wall	71.702.000	1 Pc
l = 153 mm on wall	71.703.000	1 Pc
l = 80 mm in wall	71.702.001	1 Pc
l = 153 mm in wall	71.703.001	1 Pc

similar to illustration

MAINPRESS



Crossing tee

Description/Dim.	Code	PU
16 x 16 x 16	41.310.111	1 Pc
20 x 16 x 16	41.310.211	1 Pc
20 x 16 x 20	41.310.221	1 Pc
20 x 20 x 20	41.310.222	1 Pc



Anchor hook

Description/Dim.	Code	PU
80 mm, single	800.907	100 Pcs
85 mm, double	801.007	100 Pcs

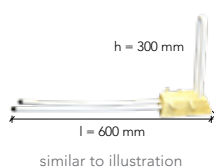

Radiator terminal box

Description/Dim.	Code	PU
Radiator terminal box 16 x 2,0	81.900.101	1 Pc



Fitting rack

Description/Dim.	Code	PU
Fitting rack, empty	60.953.000	1 Pc



Fitting case

Description/Dim.	Code	PU
Fitting case, empty	60.951.007	1 Pc



Radiator connection nipples

Description/Dim.	Code	PU
Radiator connection nipples	70.709.066	2 Pcs



Joint for valve radiators

Description/Dim.	Code	PU
Twofold joint 3/4"	80.902.200	1 Pc
Twofold joint square form 3/4"	80.902.201	1 Pc



Compression fitting

Description/Dim.	Code	PU
16 x 2,0 x 3/4"	70.709.061	2 Pcs
20 x 2,25 x 3/4"	70.709.068	2 Pcs



Attachment fitting for baseboard

Description/Dim.	Code	PU
Attachment fitting for baseboard	80.902.300	1 Pc
End cap	80.902.302	1 Pc



Euro cone adapter

Description/Dim.	Code	PU
3/4"	80.902.303	10 Pcs



MAINPRESS adapter

Description/Dim.	Code	PU
16 x 2,0	80.902.320	1 Pc



Set 1: Radial compression tool set ACO103

Description/Dim.	Code	PU
Radial compression tool ACO103 set	90.100.065	1 Set
Set consist of:		
Radial compression tool ACO103	60.953.106	1 Pc
Replacement battery 12V Li-Ion 2,0 Ah	60.950.027.1	1 Pc
Battery charger 220-240V 50-60 Hz for 12V	60.952.212.1	1 Pc
Case for ACO103	60.951.109	1 Pc



Manual radial compression tool

Description/Dim.	Code	PU
Manual radial compression tool	60.953.109	1 Pc
Inset 16	60.953.111	1 Pc
Inset 20	60.953.112	1 Pc



Scissor

Description/Dim.	Code	PU
16 - 20	60.950.014	1 Pcs
Replacement blade	60.950.114	1 Pcs



Set 2: Radial compression tool set ACO103 with press jaws

Description/Dim.	Code	PU
Radial compression tool ACO103 with press jaws set	90.100.070	1 Set
Set consist of:		
Radial compression tool ACO103	60.953.106	1 Pc
Pressjaw ACO103 U 16	60.953.271	1 Pc
Pressjaw ACO103 U 20	60.953.272	1 Pc
Pressjaw ACO103 U 25	60.953.273	1 Pc
Replacement battery 12V Li-Ion 2,0 Ah	60.950.027.1	1 Pc
Battery charger 220-240V 50-60 Hz for 12V	60.952.212.1	1 Pc
Case for ACO103	60.951.109	1 Pc



Pipe cutter

Description/Dim.	Code	PU
16 - 40	60.950.011	1 Pcs
Replacement blade	60.950.112	1 Pcs



Pipe cutter

Description/Dim.	Code	PU
16 - 63	60.950.013	1 Pc



Set 3: Radial compression tool set ACO203

Description/Dim.	Code	PU
Radial compression tool ACO203 set	90.100.066	1 Set
Set consist of:		
Radial compression tool ACO203	60.952.301	1 Pc
Replacement battery 18V Li-Ion 2,0 Ah	60.952.302	1 Pc
Battery charger 220-240V 50-60 Hz for 18V	60.952.303	1 Pc
Case for ACO203	60.951.110	1 Pc



Bending spring

Description/Dim.	Code	PU
Ø 16 IS	60.950.040	1 Pc
Ø 20 IS	60.950.047	1 Pc
Ø 25 IS	60.950.042	1 Pc
Ø 16 OS	60.950.140	1 Pc
Ø 20 OS	60.950.141	1 Pc
Ø 25 OS	60.950.142	1 Pc
Ø 32 OS	60.950.143	1 Pc



Set 4: Radial compression tool set ACO203 with press jaws

Description/Dim.	Code	PU
Radial compression tool ACO203 with press jaws set	90.100.073	1 Set
Set consist of:		
Radial compression tool ACO203	60.952.301	1 Pc
Pressjaw ACO203 U 16	60.953.001	1 Pc
Pressjaw ACO203 U 20	60.953.002	1 Pc
Pressjaw ACO203 U 25	60.953.003	1 Pc
Pressjaw ACO203 U 32	60.953.004	1 Pc
Replacement battery 18V Li-Ion 2,0 Ah	60.952.302	1 Pc
Battery charger 220-240V 50-60 Hz for 18V	60.952.303	1 Pc
Case for ACO203	60.951.110	1 Pc



Universal bevelling tool

Description/Dim.	Code	PU
Ø 16 / 20 / 25	60.953.212	1 Pc



Bevelling tool

Description/Dim.	Code	PU
Bevelling tool 16	60.953.217	1 Pc
Bevelling tool 20	60.953.218	1 Pc
Bevelling tool 25	60.953.219	1 Pc
Bevelling tool 32	60.953.213	1 Pc
Bevelling tool 40	60.953.214	1 Pc
Bevelling tool 50	60.953.215	1 Pc
Bevelling tool 63	60.953.216	1 Pc



Mainfloor

Underfloor Heating System

MAINFLOOR - UNDERFLOOR HEATING

The MAINFLOOR underfloor heating offers increased living comfort and a higher living quality. Enjoy constant temperatures in all rooms and the heating remains invisible.

One option to mount the underfloor heating system is the approved **stapler system**, which is characterized by uncomplicated and quick-routing processing. The pipe is fixed to the insulation sheet with the help of PE staplers. The especially designed stapler needles are connected by means of hot welding, which offers substantial advantages as regards to the processing with the MAINCOR stapler device. It is particularly

suited for flowing screed and anhydrite screed.

When using the **rail system**, the pipes are fixed with the help of the self-adhesive MAINCOR fixing rail. Routing rails offers the advantage of being able to modify the heating circuits retrospectively as desired without damaging the underlying insulation. It offers good acoustic insulation as the impact-noise insulation is not penetrated.

The **pipe positioning panel system** allows a fast, easy and effective installation with absolute security of fixation of the pipe.

The **dry construction system** with a low floor construction and a low weight has essential advantages regarding new and old buildings. Considerably quicker controllability is an additional benefit.

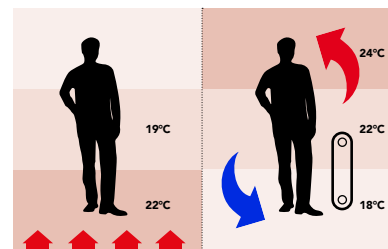

DRY CONSTRUCTION SYSTEM

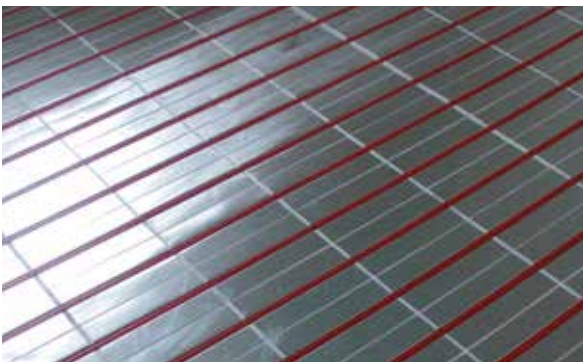

STAPLER SYSTEM



RAIL SYSTEM



PIPE POSITIONING PANEL SYSTEM



MAINFLOOR



PE-RT pipe with EVOH (5-layer)

Description/Dim.	Code	PU
14 x 2,0	501.400.346.00	600 m
15 x 1,5	551.500.313.00	300 m
15 x 1,5	551.500.316.00	600 m
16 x 1,5	551.600.343.00	300 m
16 x 1,5	551.600.346.00	600 m
16 x 2,0	501.600.343.00	300 m
16 x 2,0	501.600.346.00	600 m
17 x 2,0	501.700.343.00	300 m
17 x 2,0	501.700.346.00	600 m
18 x 2,0	501.800.343.00	300 m
18 x 2,0	501.800.345.00	500 m
20 x 2,0	502.000.343.00	300 m
20 x 2,0	502.000.345.00	500 m
25 x 2,3	502.500.342.00	200 m



Composite pipe PE-RT / Alu / PE-RT

Description/Dim.	Code	PU
16 x 2,0	416.002.130.0	300 m
16 x 2,0	416.002.150.0	500 m



PE-Xa pipe with EVOH (5-layer)

Description/Dim.	Code	PU
16 x 2,0	52.160.014.300	300 m
16 x 2,0	52.160.014.600	600 m
17 x 2,0	52.170.014.300	300 m
17 x 2,0	52.170.014.600	600 m



Set of slide seal coupler, for the connection of floor heating pipes

Description/Dim.	Code	PU
Coupler set 15 x 1,5	30.100.015	1 Set
Coupler set 16 x 1,5	30.100.115	1 Set
Coupler set 16 x 2,0	30.100.000	1 Set
Coupler set 17 x 2,0	30.100.111	1 Set
Coupler set 16 x 2,0 / 17 x 2,0	30.100.121	1 Set
Coupler set 20 x 2,0	30.100.232	1 Set



Press coupler for the connection of floor heating pipes

Description/Dim.	Code	PU
16 x 16	31.100.101	10 Pcs
20 x 20	31.100.202	10 Pcs

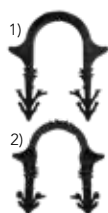

U-clips, stored

Description/Dim.	Code	PU
1) 14 - 20 mm / Length 40 mm	50.903.021	1.000 Pcs
2) 14 - 18 mm / Length 39 mm (NEO)	50.903.321	1.000 Pcs



Rail-fix

Description/Dim.	Code	PU
Rail-fix 14	50.903.136	100 m
Rail-fix 16/17	50.903.036	100 m
Rail-fix 20	50.903.236	100 m



Manual fixing clip

Description/Dim.	Code	PU
45 mm	220.407	1.000 Pcs



Pipe leading elbow

Description/Dim.	Code	PU
10 - 18	50.903.235	1 Pc
20	50.903.237	1 Pc
25	50.903.238	1 Pc
32	50.903.239	1 Pc



Suppression plug

Description/Dim.	Code	PU
80 mm	110.500	100 Pcs



Split PE protective pipe

Description/Dim.	Code	PU
23 x 400 mm	610.807	50 Pcs
23 mm (coil)	610.850	50 m



Insulation roll

Description/Dim.	Code	PU
30-2 WLG 040/5 kPA	50.903.020	1 Roll/10 m ²
20-2 WLG 045/4 kPA	50.903.034	1 Roll/10 m ²
25-2 WLG 045/4 kPA	50.903.252	1 Roll/10 m ²
30 WLG 035/100 kPA	50.903.023.5	10 m ²



Air cushioned insulating film

Description/Dim.	Code	PU
Insulating film	50.903.019	1 Roll/75 m ²

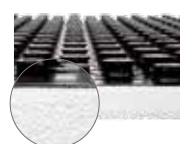

Pipe positioning panel premium 14 - 17 mm

Description/Dim.	Code	PU
Panel without insulation	51.903.060	13,44 m ²
Panel 11 Premium	51.903.061	14,56 m ²
Panel 30-2 Premium	51.903.062	6,72 m ²

Edge - insulation strip

Description/Dim.	Code	PU
8 x 150 mm	50.903.022	1 Roll/25 m
8 x 150 mm, with self-adhesive tape	50.903.039	1 Roll/25 m
10 x 150 mm	50.903.222	1 Roll/25 m

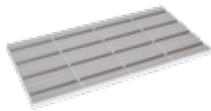
Pipe positioning panel for dry construction, aluminium plate

Description/Dim.	Code	PU
Panel Alu-distance 12,5	51.903.030	10 Pcs
Panel Alu-distance 25	51.903.031	10 Pcs

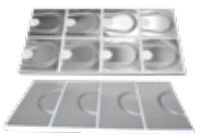
Turn panel for dry construction, aluminium plate

Description/Dim.	Code	PU
Turn panel for dry construction distance 12,5	51.903.035	10 Pcs
Turn panel for dry construction distance 25	51.903.036	10 Pcs

Turn panel for dry construction

Description/Dim.	Code	PU
Turn panel for dry construction distance 12,5	51.903.044	10 Pcs
Turn panel for dry construction distance 25	51.903.045	10 Pcs

Conversion panel for dry construction

Description/Dim.	Code	PU
Conversion panel for dry construction	51.903.033	10 Pcs

Filling element

Description/Dim.	Code	PU
Filling element Measures: 1.000 x 500 x 30 mm	51.903.037	10 Pcs

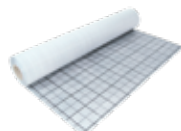
Foil with raster orientation

Description/Dim.	Code	PU
Foil with raster orientation	51.903.038	1 Roll/103 m ²

Heat conduction sheet made of steel

Description/Dim.	Code	PU
Heat conduction sheet	51.903.040	1 Pc

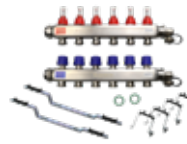
Manifold stainless steel with integrated flow meter 1" short

Description/Dim.	Code	PU
2 Circuits	50.900.002	1 Pc
3 Circuits	50.900.003	1 Pc
4 Circuits	50.900.004	1 Pc
5 Circuits	50.900.005	1 Pc
6 Circuits	50.900.006	1 Pc
7 Circuits	50.900.007	1 Pc
8 Circuits	50.900.008	1 Pc
9 Circuits	50.900.009	1 Pc
10 Circuits	50.900.010	1 Pc
11 Circuits	50.900.011	1 Pc
12 Circuits	50.900.012	1 Pc
13 Circuits	50.900.013	1 Pc
14 Circuits	50.900.014	1 Pc
15 Circuits	50.900.015	1 Pc
16 Circuits	50.900.016	1 Pc

Manifold stainless steel with integrated flow meter 1" long

Description/Dim.	Code	PU
2 Circuits	50.940.002	1 Pc
3 Circuits	50.940.003	1 Pc
4 Circuits	50.940.004	1 Pc
5 Circuits	50.940.005	1 Pc
6 Circuits	50.940.006	1 Pc
7 Circuits	50.940.007	1 Pc
8 Circuits	50.940.008	1 Pc
9 Circuits	50.940.009	1 Pc
10 Circuits	50.940.010	1 Pc
11 Circuits	50.940.011	1 Pc
12 Circuits	50.940.012	1 Pc
13 Circuits	50.940.013	1 Pc
14 Circuits	50.940.014	1 Pc
15 Circuits	50.940.015	1 Pc
16 Circuits	50.940.016	1 Pc

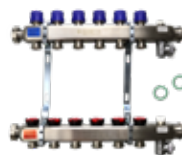
Manifold stainless steel with integrated flow limiter 1" long

Description/Dim.	Code	PU
2 Circuits	50.920.002	1 Pc
3 Circuits	50.920.003	1 Pc
4 Circuits	50.920.004	1 Pc
5 Circuits	50.920.005	1 Pc
6 Circuits	50.920.006	1 Pc
7 Circuits	50.920.007	1 Pc
8 Circuits	50.920.008	1 Pc
9 Circuits	50.920.009	1 Pc
10 Circuits	50.920.010	1 Pc
11 Circuits	50.920.011	1 Pc
12 Circuits	50.920.012	1 Pc
13 Circuits	50.920.013	1 Pc
14 Circuits	50.920.014	1 Pc
15 Circuits	50.920.015	1 Pc
16 Circuits	50.920.016	1 Pc

MAINFLOOR



Flow meter

Description/Dim.	Code	PU
(1) Replacement flow meter	50.903.006	1 Pc
(2) Taconova flow meter	50.903.106	1 Pc



Heat flow meter connection kit, horizontal

Description/Dim.	Code	PU
HFM, horizontal	50.903.069	1 Pc



Heat flow meter connection kit, vertical

Description/Dim.	Code	PU
HFM, vertical	50.903.068	1 Pc



Constant control kit

Description/Dim.	Code	PU
Constant control kit	50.903.047	1 Pc



Fixing bracket for water meter

Description/Dim.	Code	PU
Fixing bracket blue	50.903.061	1 Pc
Fixing bracket red	50.903.062	1 Pc
Fixing bracket set (blue/red)	50.903.060	1 Set



Compression fitting

Description/Dim.	Code	PU
(1) 15 x 1,5 x 3/4"	70.709.075	2 Pcs
(2) 14 x 2,0 x 3/4"	70.709.069	2 Pcs
(2) 16 x 1,5 x 3/4"	70.709.060	2 Pcs
(2) 16 x 2,0 x 3/4"	70.709.061	2 Pcs
(2) 17 x 2,0 x 3/4"	70.709.063	2 Pcs
(2) 18 x 2,0 x 3/4"	70.709.078	2 Pcs
(2) 20 x 2,0 x 3/4"	70.709.071	2 Pcs
(2) 25 x 2,3 x 1"	70.709.072	2 Pcs

similar to illustration



Compression fitting „Plus“ made of brass

Description/Dim.	Code	PU
16 x 2,0 x 3/4"	70.709.077	2 Pcs
17 x 2,0 x 3/4"	70.709.088	2 Pcs



Coupling nipple euro cone

Description/Dim.	Code	PU
3/4" / 3/4"	70.709.070	5 Pcs



Connection nipple for manifold

Description/Dim.	Code	PU
Connection nipple	50.903.071	2 Pcs



Ball valve

Description/Dim.	Code	PU
1" FT x 1" MT	50.903.002	2 Pcs
1" FT x 1" MT edge	50.903.043	2 Pcs
3/4" FT x 1" MT	50.903.101	2 Pcs
3/4" FT x 1" MT edge	50.903.041	2 Pcs
Set 1" FT x 1" MT edge, one longer version	50.903.065	1 Set



Distribution cabinet, on-wall

Description/Dim.	Code	PU
on-wall 5 (3 - 5 Circuits)	50.922.002	1 Pc
on-wall 8 (6 - 8 Circuits)	50.922.003	1 Pc
on-wall 11 (9 - 11 Circuits)	50.922.004	1 Pc
on-wall 12 (12 Circuits or higher)	50.922.005	1 Pc



Distribution cabinet, in-wall 110 - 140 mm deep

Description/Dim.	Code	PU
in-wall 5 (2 - 5 Circuits)	50.911.002	1 Pc
in-wall 8 (6 - 8 Circuits)	50.911.003	1 Pc
in-wall 11 (9 - 11 Circuits)	50.911.004	1 Pc
in-wall 12 (12 - 14 Circuits)	50.911.005	1 Pc
in-wall 16 (15 Circuits or higher)	50.911.006	1 Pc
Lock	50.911.001	1 Pc



Distribution cabinet, in-wall 80 mm deep

Description/Dim.	Code	PU
in-wall 80 mm (2 - 5 Circuits)	50.933.002	1 Pc
in-wall 80 mm (6 - 8 Circuits)	50.933.003	1 Pc
in-wall 80 mm (9 - 11 Circuits)	50.933.004	1 Pc
in-wall 80 mm (12 Circuits or higher)	50.933.005	1 Pc
Lock	50.911.001	1 Pc

**Distribution cabinet, in-wall
110 - 140 mm deep with DIN rail**

Description/Dim.	Code	PU
in-wall 8 (5 - 9 Circuits)	50.911.013	1 Pc
in-wall 11 (10 - 12 Circuits)	50.911.014	1 Pc
in-wall 12 (13 - 14 Circuits)	50.911.015	1 Pc

Actuator NEO

Description/Dim.	Code	PU
230 V	50.903.050	1 Pc

Actuator 4.0

Description/Dim.	Code	PU
230 V	50.903.011	1 Pc
24 V	50.903.111	1 Pc
Adapter for actuator (replacement part)	50.903.344	1 Pc

Regulation-Box RTL white 15 1/2

Description/Dim.	Code	PU
Regulation-Box RTL white 15 1/2	50.903.107	1 Pc

Controller on-wall, heating

Description/Dim.	Code	PU
230 V	50.903.012	1 Pc
24 V	51.903.012	1 Pc

**Controller on-wall,
heating / cooling**

Description/Dim.	Code	PU
230 V	50.903.016	1 Pc
24 V	51.903.016	1 Pc

**Controller in-wall,
heating / cooling**

Description/Dim.	Code	PU
50 x 50 mm	50.903.013	1 Pc

**Digital controller
„Standard 4.0“ (for heating)**

Description/Dim.	Code	PU
230 V	50.903.113	1 Pc
24 V	51.903.113	1 Pc

**Digital controller „Control 4.0“
(for heating / cooling)**

Description/Dim.	Code	PU
230 V	50.903.114	1 Pc
24 V	51.903.114	1 Pc
External temperature sensor	50.903.056	1 Pc

**Terminal strip „Standard 4.0“
(for heating)**

Description/Dim.	Code	PU
24 V / 230 V 6 zones	50.903.014	1 Pc
24 V / 230 V 10 zones	50.903.045	1 Pc

**Terminal strip „Standard Plus 4.0“
(for heating / cooling)**

Description/Dim.	Code	PU
230 V 6 zones	50.903.015	1 Pc
230 V 10 zones	50.903.059	1 Pc
24 V 6 zones	51.903.015	1 Pc
24 V 10 zones	51.903.059	1 Pc
Connection for terminal strip 230 V	50.903.054	1 Pc
External system clock 2 channel	50.903.055	1 Pc
Safety transformer 24 V	51.903.047	1 Pc

**Wireless controller on-wall,
smart NEO**

Description/Dim.	Code	PU
Analog	50.950.030	1 Pc

**Wireless controller on-wall digital,
smart NEO**

Description/Dim.	Code	PU
Digital	50.950.033	1 Pc

**Wireless controller in-wall digital,
smart NEO**

Description/Dim.	Code	PU
Digital in-wall	50.950.013	1 Pc

**Wireless terminal strip,
smart NEO**

Description/Dim.	Code	PU
6 zones	50.950.031	1 Pc
10 zones	50.950.032	1 Pc
Connection for terminal strip 230 V	50.903.054	1 Pc

MAINFLOOR



Multi I/O box, smart NEO

Description/Dim.	Code	PU
Multi I/O box	50.950.050	1 Pc



Access point, smart NEO

Description/Dim.	Code	PU
Access point	50.950.051	1 Pc



Manual compression tool

Description/Dim.	Code	PU
Manual compression tool	60.950.102	1 Pc
Sliding jaw kit 10	60.950.182	1 Set
Sliding jaw kit 16 - 17	60.950.177	1 Pc
Sliding jaw kit 20	60.950.178	1 Pc
Tool case	60.950.181	1 Pc



Manual expansion tool

Description/Dim.	Code	PU
Expansion tool	60.950.030	1 Pc
Expansion head 10	60.950.183	1 Pc
Expansion head 15	60.950.038	1 Pc
Expansion head 16	60.950.031	1 Pc
Expansion head 17	60.950.131	1 Pc
Expansion head 20	60.950.132	1 Pc



Stapler

Description/Dim.	Code	PU
14/16/17	TG.220.207	1 Pc
Extension handle	VTG.222.207	1 Pc



Decoiler

Description/Dim.	Code	PU
Decoiler	60.950.051	1 Pc
Decoiler with straightening	60.950.151	1 Pc
(1) Adapter for pipe straightening and guidance	60.950.251	1 Pc
(2) Pipe guidance	60.950.351	1 Pc



Tape dispenser

Description/Dim.	Code	PU
Tape dispenser	60.950.052	1 Pc



Hot cutting tool

Description/Dim.	Code	PU
Hot cutting tool	51.903.039	1 Pc



Adhesive tape, transparent

Description/Dim.	Code	PU
75 mm (66 m long)	50.903.028	1 Coil

Renovation system



PE-RT pipe with EVOH (5-layer)

Description/Dim.	Code	PU
10 x 1,3	501.000.312.00	200 m



Sliding sleeve

Description/Dim.	Code	PU
10	20.000.010	10 Pcs



Coupler

Description/Dim.	Code	PU
10 x 10	30.100.010	10 Pcs
16 x 10	30.100.110	10 Pcs



Connector, male thread

Description/Dim.	Code	PU
10 x 1/2" MT	30.202.001	10 Pcs



Tee

Description/Dim.	Code	PU
16 x 10 x 16	40.300.101	10 Pcs



Joint euro cone with joint union nut

Description/Dim.	Code	PU
10 x 3/4" euro cone	30.206.010	10 Pcs



Compression fitting

Description/Dim.	Code	PU
10 x 3/4" euro cone	70.709.265	2 Pcs



Pipe positioning panel 10 - 12 mm

Description/Dim.	Code	PU
Pipe positioning panel without insulation	51.903.160	9,6 m ²



Rail-fix NEO

Description/Dim.	Code	PU
NEO Rail-fix 10	50.903.337	1 Pc



Edge - insulating strip PE

Description/Dim.	Code	PU
PE-insulating strip 50 x 5 mm	50.903.122	1 Roll/25 m



Sliding jaw kit

Description/Dim.	Code	PU
Sliding jaw kit 10	60.950.182	1 Pc

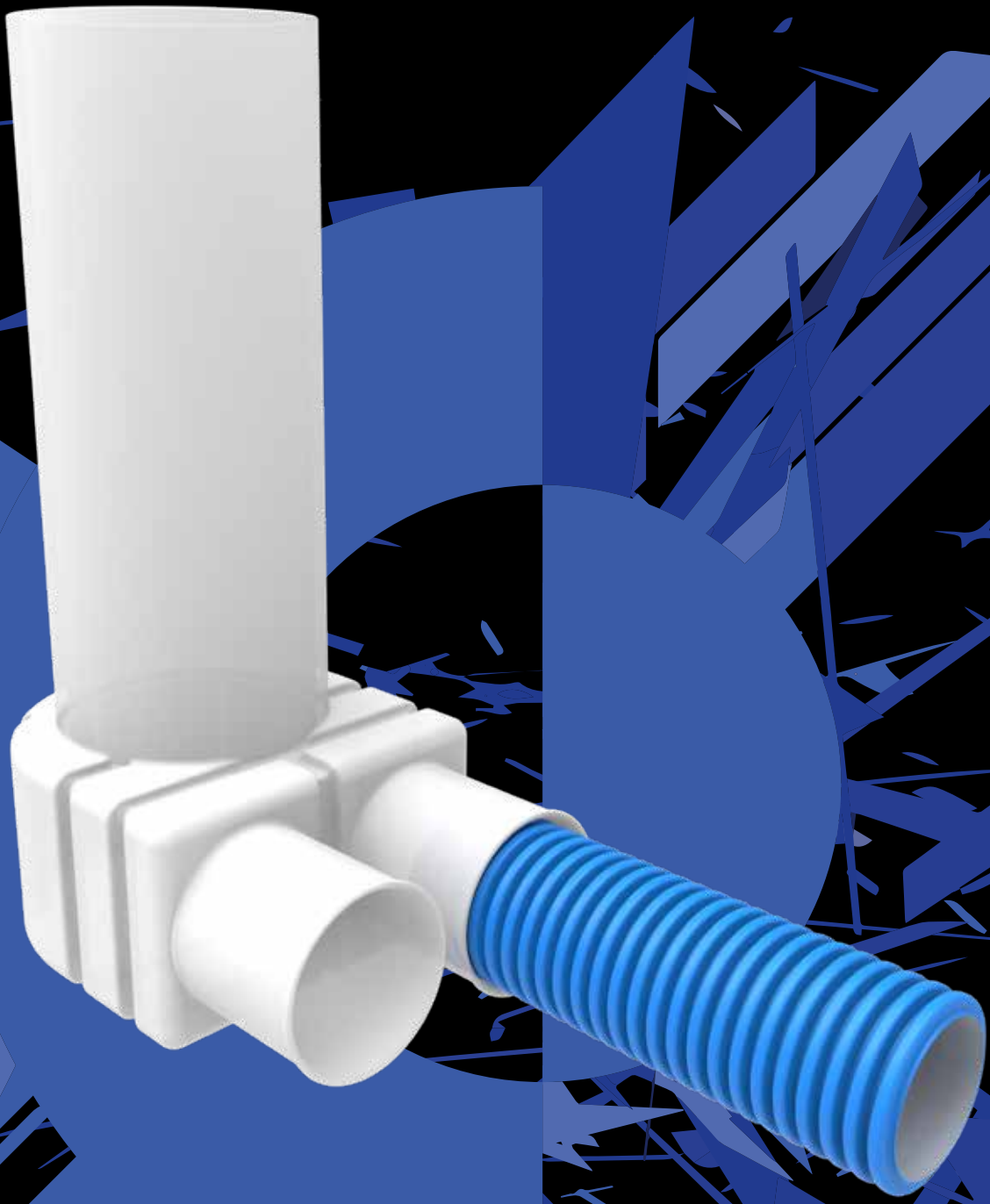

Mainair

Residential Ventilation System

MAINAIR - RESIDENTIAL VENTILATION SYSTEM

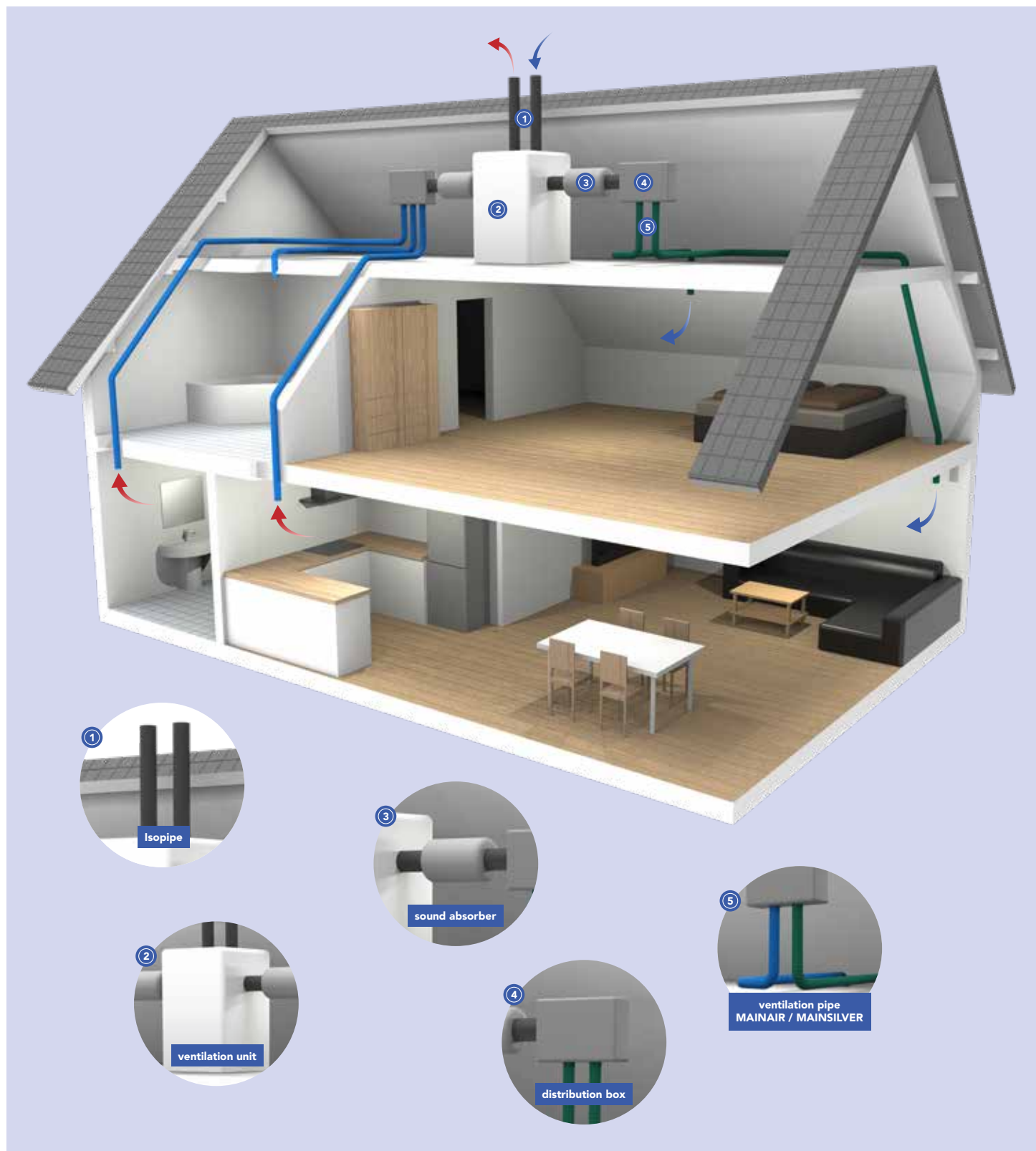



MAINAIR ventilation pipe

Description/Dim.	Code	PU
63 x 6,3	706.300.142.050	50 m
75 x 7,0	707.500.142.050	50 m
90 x 7,5	709.000.142.050	50 m



MAINSILVER ventilation pipe

Description/Dim.	Code	PU
75 x 7,0	7A7.500.185.050	50 m



Ventilation connection and distribution channel, single

Description/Dim.	Code	PU
125 / 75	80.000.129	1 Pc
125 / 90	80.000.130	1 Pc



Ventilation connection and distribution channel, double

Description/Dim.	Code	PU
125 / 63 / 63	80.000.106	1 Pc
125 / 75 / 75	80.000.105	1 Pc
125 / 90 / 90	80.000.131	1 Pc



Ventilation connection and distribution channel, axial

Description/Dim.	Code	PU
125 / 75 / 75 axial	80.001.117	1 Pc



Ventilation connection and distribution channel, three-way

Description/Dim.	Code	PU
125 / 63 / 63 / 63	80.000.108	1 Pc
125 / 75 / 75 / 75	80.000.116	1 Pc



Distribution box, plastic

Description/Dim.	Code	PU
63-125-W Pipe connection DIM 125 Exits: 6 nozzles DIM 63, 2 end caps	80.100.040	1 Pc
75-125-W Pipe connection DIM 125 Exits: 5 nozzles DIM 75, 2 end caps	80.100.041	1 Pc
63-160-W Pipe connection DIM 160 Exits: 12 nozzles DIM 63, 3 end caps	80.100.042	1 Pc
75-160-W Pipe connection DIM 160 Exits: 10 nozzles DIM 75, 2 end caps	80.100.043	1 Pc
63-180-W Pipe connection DIM 180 Exits: 18 nozzles DIM 63, 4 end caps	80.100.044	1 Pc
75-180-W Pipe connection DIM 180 Exits: 15 nozzles DIM 75, 3 end caps	80.100.045	1 Pc
75-125-W Pipe connection DIM 125 Exits: 6 nozzles DIM 75	on request	1 Pc
90-160-W Pipe connection DIM 160 Exits: 6 nozzles DIM 90	on request	1 Pc
63-125-W Pipe connection DIM 125 Exits: 6 + 1 nozzle DIM 63	on request	1 Pc
75-125-W Pipe connection DIM 125 Exits: 5 + 1 nozzle DIM 75	on request	1 Pc



Spider distribution box, plastic

Description/Dim.	Code	PU
160 / 12 x 63	80.100.046	1 Pc
160 / 18 x 63	80.100.047	1 Pc
160 / 8 x 75	80.100.048	1 Pc
160 / 12 x 75	80.100.049	1 Pc
160 / 8 x 90	80.100.050	1 Pc



Distribution box, plastic - left and right

Description/Dim.	Code	PU
160 / 6 x 75 right	80.000.120	1 Pc
160 / 8 x 75 right	80.000.122	1 Pc
160 / 10 x 75 right	80.000.123	1 Pc
160 / 12 x 75 right	80.000.127	1 Pc
160 / 6 x 75 left	80.000.121	1 Pc
160 / 8 x 75 left	80.000.124	1 Pc
160 / 10 x 75 left	80.000.125	1 Pc
160 / 12 x 75 left	80.000.128	1 Pc



End cap for distribution channels and boxes

Description/Dim.	Code	PU
DIM 63 (blue)	39.200.0631	1 Pc
DIM 75 (blue)	39.200.0752	1 Pc
DIM 75 (red)	39.200.0751	1 Pc



End cap for ventilation pipe

Description/Dim.	Code	PU
DIM 63	39.200.063	5 Pcs
DIM 75	39.200.075	5 Pcs
DIM 90	39.200.090	5 Pcs



Double connection sleeve

Description/Dim.	Code	PU
DIM 63	39.100.063	5 Pcs
DIM 75	39.100.075	5 Pcs
DIM 90	39.100.090	5 Pcs



Sealing ring

Description/Dim.	Code	PU
DIM 63	77.900.063	10 Pcs
DIM 75	77.900.075	10 Pcs
DIM 90	77.900.090	10 Pcs



Elbow, 90°

Description/Dim.	Code	PU
DIM 63	80.387.40	1 Pc
DIM 75	80.387.97	1 Pc



Isopipe

Description/Dim.	Code	PU
DIM 125	80.480.15	2 m
DIM 160	80.480.16	2 m
DIM 180	80.480.17	2 m



Isopipe elbow, 45°

Description/Dim.	Code	PU
DIM 125	80.480.03	1 Pc
DIM 160	80.480.19	1 Pc
DIM 180	80.480.39	1 Pc



Isopipe elbow, 90°

Description/Dim.	Code	PU
DIM 125	80.480.02	1 Pc
DIM 160	80.480.18	1 Pc
DIM 180	80.480.40	1 Pc



Isopipe plug-in connector

Description/Dim.	Code	PU
DIM 125	80.480.01	1 Pc
DIM 160	80.480.20	1 Pc
DIM 180	80.480.41	1 Pc



Reducer for Isopipe

Description/Dim.	Code	PU
DIM 160/125	80.480.23	1 Pc
DIM 180/125	80.480.13	1 Pc
DIM 180/160	80.480.14	1 Pc



Supply air valve

Description/Dim.	Code	PU
DIM 125	80.380.02	1 Pc



Exhaust air valve

Description/Dim.	Code	PU
DIM 125	80.380.04	1 Pc



Cutter for ventilation pipe

Description/Dim.	Code	PU
DIM 75 & 90	80.807.590	1 Pc

Further products available upon request.



GERMANY

Hotline: +49 9721 659 77-100

Fax: +49 9721 659 77-200

Homepage: www.maincor.de

E-Mail: info@maincor.de

MAINCOR Rohrsysteme GmbH & Co. KG

Silbersteinstraße 14

97424 Schweinfurt



www.maincor.de



info@maincor.de



facebook.com/MaincorRohrsysteme